



# 500 bariatric

TREATMENT CHAIR



ENJOY QUALITY AND DESIGN

E

# 500 bariatric

Item No.: 1500 0002

The 500 **bariatric** - our ultra rugged treatment chair, with an extra 760 mm of reclining surface, increased lifting capacity and 350 kg payload capacity.

**Power and comfort**  
for obese patients



## Designed for maximum load

### Chassis

Rugged steel frame and highly resilient steel chassis, galvanized and powder-coated in anthracite. Four fully rotating double-run castors for spine friendly and easy rolling motion. Outstanding driving characteristics.

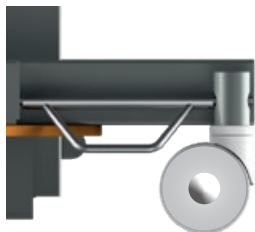

### Operation by hand

Hand control with 3 freely programmable memory positions and reset button.



### Operation by foot

Removable foot keypad for infinite electronic height and head adjustment.



## Mechanical maneuvering aid on the chassis



### Operation via foot lever on the chassis

Activation of directional guidance

Pushing from the head direction

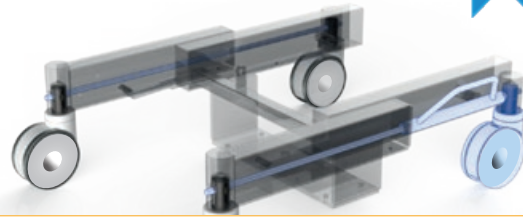

Pushing from the foot direction

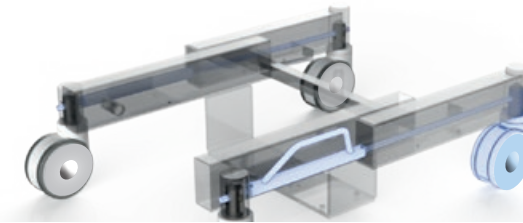
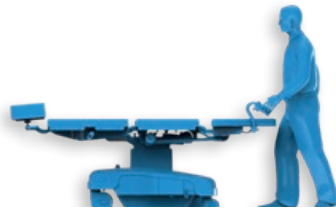

## Braking system

### Manual adjustable foot lever

Casters are braked

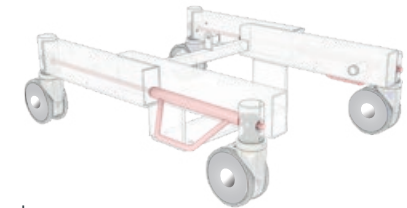

Casters are released, directional guidance is deactivated

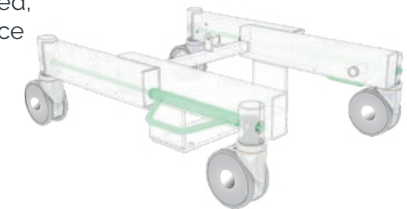

## Precise positioning of the head part

### Headrest

3D and longitudinally adjustable headrest element with head molding and neck support for guaranteed safe and correct head positioning.

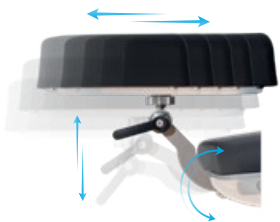

## Armrests

Hinged and removeable armrests for easy entry and exit as well as transfer of the patient.



## Components

### Additional handles / shoulder parts and more

Discover additional features and extensive components on page 40-41.



# Technical specifications



## Chassis

- Frame profile 90 x 50 mm
- Outside length 935 mm
- Outside width 850 mm
- Zinc-plated and powder-coated according to RAL
- Central brake on both sides works on all four castors. The direction of two castors can be independently adjusted.
- Double rimmed castors  $\varnothing$  150 mm
- Detachable foot keypad (total, head up / down)
- Emergency stop button
- Visible screws are made of stainless steel

## Frame

- 4-part support frame (head, back, seat, leg part)
- Length 1,880 – 1,940 mm
- Width 760 mm
- Width incl. armrest 1,030 mm
- Entry height 620 mm
- Removeable upholstery

	Angle	Dimensions (L x W)
• Head part	-29° / +31°	255 x 245 mm
• Back part	0° / +85°	610 x 760 mm
• Seat part	-6° / +35°	450 x 760 mm
• Leg part	0° / -70°	510 x 760 mm
• Height adjustment		680 – 940 mm
• Armrests	0° / +180°	(2 x) 470 x 75 mm
• Trendelenburg	-35° / Reverse Trendelenburg +6°	

## Electrical control

- All components according to IPX4
- Hand control with 3 individually programmable memory positions and reset button
- Foot keypad with 4 foot switches

### Electric Drives

- Head, back, seat, leg part, total up/down
- Trendelenburg / Reverse Trendelenburg

## Lifting column

- Max. lifting 260 mm
- Max. patient weight 350 kg
- Motors IPX4 with reed contacts, to be memorized

## Trendelenburg / Reverse Trendelenburg



## Back part / Leg part



## Height adjustment

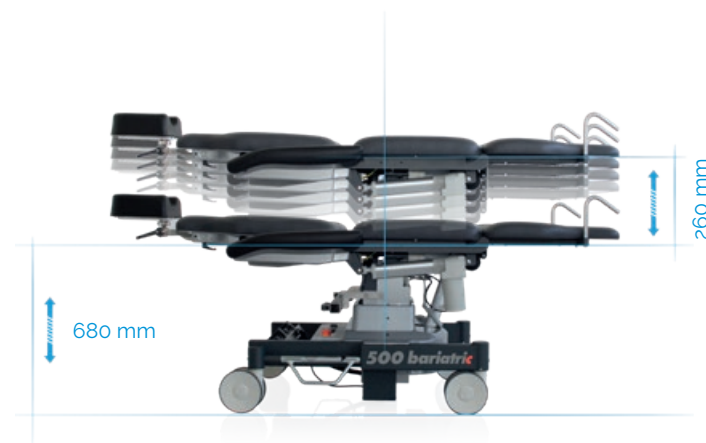

## Powerful accumulators

- Battery box with 2 batteries (lead-gel), pollution free, maintenance-free, cadmium-free 2 x 12 V, 7,2 Ah
- As back-up-system exchangeable without tools
- Acoustic low voltage signal for discharge protection
- Universal battery charger Input: 100-240 V  
Output: 24 V

### Operating time per battery charge

- Measured by operating circle (Prepare-Operate-Recover)
- Quantity of operating circles depends on individual operation

80 OPs

## Further technical details

- Chair has detachable, swiveling armrests made completely with PUR foam
- All touchable metal parts are grounded
- Detachable seat for service friendly access to electric components

Max. Load 350 kg

Weight 145 kg

Subject to technical modifications.

## Mains-free operation

Easy recharging of the equipment thanks to charging adapter and integrated battery charger circuit board.

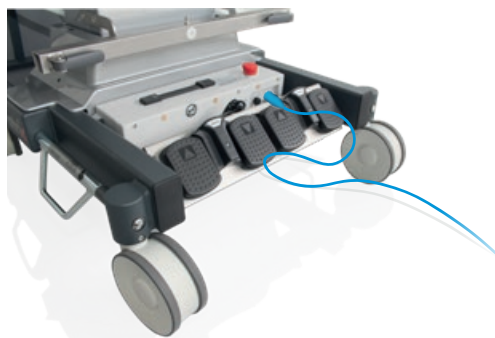

## Equipment protection

### Cover drape *stayClean*

2,000 x 730 mm, box á 160 Pieces  
4 x 40 Pieces

Item No.: 3034 0014

Page 72



## Simple battery replacement

Extra security thanks to exchangeable battery box. Easy replacement of discharged battery boxes.

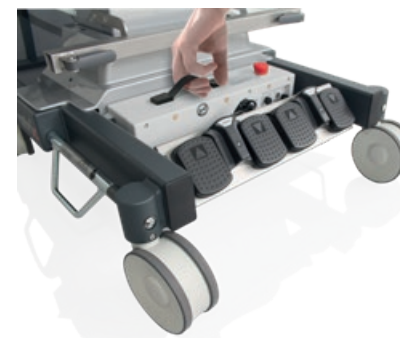

## Colour card

Standard colour

anthracite Item No.: 3037 0052

„Pandoria Plus“  
Page 109

„Tundra skai“  
Page 108



# Components



PERFORMANCE  
LINE



**500 *bariatric***  
Item No.: 1500 0002



Backup battery

Item No.: 3047 0000



Head part bumper  
stainless steel

Item No.: 3028 0000

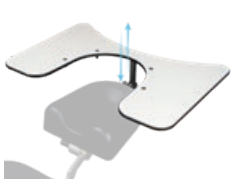

Wrist rest  
550x370 mm,  
height adjustable,  
incl. mounting plate,  
adjustment 115 mm

Item No.: 3209 0000



Wrist rest, adjustable,  
incl. mounting plate  
3013 0000,  
adjustment 115 mm

Item No.: 3014 0000

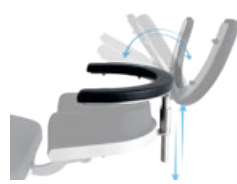

Wrist rest, adjustable, tiltable,  
incl. mounting plate  
3013 0000,  
adjustment 115 mm

Item No.: 3014 0005



Mounting plate stainless steel,  
for wrist rest 3014 0000,  
3014 0005 and 3209 0000

Item No.: 3013 0000

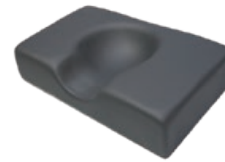

Head fixation pillow with  
hollow (rubins pillow),  
410x250 mm, height 100 mm,  
factory-fitted

Item No.: 3022 0000

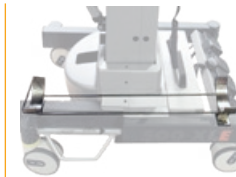

Cylinder holder

Item No.: 3072 0000



Instrument table  
500x300x15 mm, height  
adjustable, swiveling,  
detachable, incl. adapter  
(component holder  
3351 0037 not included)

Item No.: 3065 0000



Shoulder parts  
right and left

Item No.: 3071 0000



Knee half roll,  
600x280x140 mm,  
PUD-coated

Item No.: 3019 0000



Knee roll round,  
500x150 mm,  
PUD-coated

Item No.: 3050 0000



Wrist secure straps,  
pair

Item No.: 3015 0000



Body strap with Velcro straps,  
2-piece

Item No.: 3083 0000

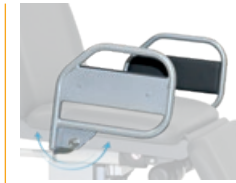

Side rails right and left,  
swiveling incl. locking,  
upholstered

Item No.: 3101 0001



Anesthesia arm board with  
universal joint,  
with wrist secure straps

Item No.: 3078 0000



Component arm stainless  
steel, swiveling,  
incl. extendible I.V. Pole  
Ø 25 mm

Item No.: 3024 0014



Component holder,  
stainless steel

Item No.: 3351 0037



Pushing handles,  
pair

Item No.: 3069 0000



Flexible surgical drape  
support rod

Item No.: 3205 0000



Flexible surgical drape  
support rod, with air  
connection

Item No.: 3206 0000



Instrument table  
*supportLine*  
height adjustable 730–985 mm  
Item No.: 3351 0026

*supportLine plus*  
height adjustable 930–1185 mm  
Item No.: 3351 0045



I.V. Pole stainless steel  
Ø 25/18 mm, one-hand  
height adjustable  
1,070–1,660 mm,  
4 hooks, max. 2 kg/hook,  
glass and holder  
(component holder  
3351 0037 not included)

Item No.: 3068 0000

# "Tundra skai"



High quality skai® material with fine calf leather grain and subdued matte-gloss-effect. The very extensive and trend-orientated colour spectrum enables many applications and combinations.

## Product Specification

- Long-lasting
- Tear resistant
- Easy to clean
- Abrasion resistant (DIN EN ISO 6570-2)
- Lightfast
- Disinfectant resistant
- Fulfills medical standard (DIN EN ISO 10993-5+10)
- Blood- and urine resistant
- Phthalate-free
- Vegan

<i>eyeForce</i>		1800 0000
<i>500 XLE</i>		1500 0006
<i>500 XLE comfort</i>		1500 0006
		+ 3037 0080
<i>500 bariatric</i>		1500 0002
<i>500 XLS</i>		1500 0005
<i>500 ECO</i>		1500 0008
<i>400 XL</i>		1400 0001
<i>surgiForce</i>	Formed seat	2600 0008
<i>surgiForce light</i>	Formed seat	2600 0009
<i>surgiLine</i>	Formed seat	2200 0008
<i>assistLine</i>		2400 0015
<i>motionLine</i>		1700 0000
<i>motionLine-E</i>		1700 0001

+ Item No.: 3037 0...



F6461198  
Item No.: .....134



F6461210  
Item No.: .....057



F6461636  
Item No.: .....094



F6461230  
Item No.: .....058



F6461610  
Item No.: .....153



F6461495  
Item No.: .....067



F6461456  
Item No.: .....001



F6461338  
Item No.: .....008



F6461288  
Item No.: .....007



F6461550  
Item No.: .....070



F6461608  
Item No.: .....075



F6461496  
Item No.: .....068



F6461609  
Item No.: .....076



F6461581  
Item No.: .....073



F6461196  
Item No.: .....051



F6461453  
Item No.: .....062



F6461356  
Item No.: .....059



F6461381  
Item No.: .....119



F6461354  
Item No.: .....011



F6461350  
Item No.: .....010



F6461199  
Item No.: .....054



F6461454  
Item No.: .....063



F6461557  
Item No.: .....072



F6461556  
Item No.: .....071



F6461458  
Item No.: .....066



F6461457  
Item No.: .....065



F6461607  
Item No.: .....074



F6461542  
Item No.: .....069



F6461343  
Item No.: .....009



F6461543  
Item No.: .....109



F6461455  
Item No.: .....064



F6461273  
Item No.: .....006



F6461205  
Item No.: .....056



F6461204  
Item No.: .....055



F6461357  
Item No.: .....060



F6461195  
Item No.: .....050



F6461197  
Item No.: .....052



# "Pandoria Plus"



skai® Pandoria Plus is a high-quality upholstery material, whose fine micropore structure gives a certain unobtrusiveness, which is refined by an attractive tone-in-tone effect. The very pleasant feel of the material and the excellent material characteristic and the broad, modern color spectrum make skai® Pandoria Plus universally usable.

## Product Specification

- Long-lasting
- Tear resistant
- Easy to clean
- Abrasion resistant (DIN EN ISO 5470-2)
- Resistant to oil and fat
- Lightfast
- Disinfectant resistant
- Flame protection
- Fulfills medical standard
- Resistant to sudor, blood and urine
- 0161-21 (IMO FTPC Part 8)
- Antibacterial according to JIS Z 2801
- Vegan

<b>eyeForce</b>	1800 0000
<b>500 XLE</b>	1500 0006
<b>500 XLE comfort</b>	1500 0006
	+ 3037 0080
<b>500 bariatric</b>	1500 0002
<b>500 XLS</b>	1500 0005
<b>500 ECO</b>	1500 0008
<b>400 XL</b>	1400 0001

+ Item No.: 3037 0136

+ Item No.: 3037 0...

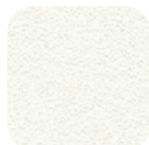

weiß F6413046  
Item No.: .....053



hellbeige F6413047  
Item No.: .....141



kiesel F6413048  
Item No.: .....158



birke F6413049  
Item No.: .....159



smoke F6413050  
Item No.: .....221



silbergrau F6413075  
Item No.: .....275



platin F6413053  
Item No.: .....161



anthrazit F6413076  
Item No.: .....276



schwarz F6413052  
Item No.: .....170



schoko F6413051  
Item No.: .....160



gletscher F6413055  
Item No.: .....162



sky F6413074  
Item No.: .....277



royal F6413056  
Item No.: .....163



smaragd F6413073  
Item No.: .....278



kaktus F6413077  
Item No.: .....281



feuer F6413058  
Item No.: .....166



kirsche F6413079  
Item No.: .....279



fuchsia F6413078  
Item No.: .....280



mais F6413057  
Item No.: .....164



limone F6413054  
Item No.: .....165

# Upgrade your OR to perfection.



*eyeForce*



*500 XLE*



*500 XLE comfort*



*500 bariatric*



*500 XLS*



*500 ECO*



*400 XL*



*motionLine*



*motionLine-E*



*surgiForce*



*surgiForce light*



*surgiTrend*



*surgiLine*



*stayClean wipes*



*stayClean*



*staySoft*



*stayClean roll*



*assistTrend*



*assistPro F*



*assistPro H*



*easyPro F*



*easyPro H*



*easyPro R*



*assistLine*



*supportLine*



*supportLine plus*

## CONTACT US



**UFSK**  
INTERNATIONAL

**OSYS**

UFSK-International OSYS GmbH  
Kirchhoffstraße 1  
93055 Regensburg  
Germany

Phone +49 (0)941 78862 15  
Fax +49 (0)941 78862 35  
Mail [info@ufsk-osys.com](mailto:info@ufsk-osys.com)  
Web [ufsk-osys.com](http://ufsk-osys.com)

**MADE IN GERMANY**  
Design | Construction | Manufacturing